



## Operating manual

for

***FMA21***



**Firmware version  
0.9.13**

# ***Safety instructions***

## **Operating manual**

Before switching on the device please make yourself familiar with the safety instructions as well as with this manual.

## **Supply connection/disconnection**

Operate the FMA 21 only with the provided power supply at an supply voltage with 100 - 240 V~/50 Hz. Make sure that the power supply has a proper earth connection. The device can only be connected to mains if all cables are connected correctly. For an absolutely safe disconnection or in case of danger you have to pull the power plug. In this case, pressing the power switch on the top of the device is not sufficient.

## **Cleaning**

Pull the power plug before cleaning the device. Use a dry cloth for cleaning.

## **Place of installation/ventilation**

- Do not expose the device to direct sun.
- Set-up the device on a safe and solid ground.
- Do not set-up the device in rooms with high humidity as condensation water may cause failures or damages.
- Heaters or other heat sources which are close by the device may also cause failures or damages.
- Avoid the contact with water or humidity.
- Make sure that the device is well ventilated. The air supply to the device by the ventilation slots at the bottom, top and back of the device must not be interrupted.
- Never block or close the device's ventilation slots as they are necessary for heat transmission.
- Ambient temperature of the device should not exceed 40 °C.

## ***Service/repairs***

All necessary repairs must be done by authorised professionals.

Do only change those settings that are explained in this operating manual.

Changing other parameters may cause expensive repairs.

Do not try to open the device by yourself. Unauthorised opening of the FMA21 makes the warranty become void.

In one of the following cases pull the power plug out of the power socket and turn to qualified personnel:

- power cable or power socket damaged
- the device was exposed to humidity or rain. Water entered or any object fell into the device.
- the device shows serious changes in its functions, it does not work properly.
- the device fell down or the housing is damaged.

## ***Disposal***

Electronic equipment is not household waste – in accordance with directive 2002/96/EC OF THE EUROPEAN PARLIAMENT AND THE COUNCIL of 27th January 2003 on used electrical and electronic equipment, it must be disposed of properly.

At the end of its service life, take this unit for disposal at a relevant official collection point.



**Caution! Do not connect the power plug to the power socket before all other cable connections are connected properly.**

# FMA21

## Instructions for use

### 1 Introduction

The **FMA21** is a scoring machine of the latest generation exclusively developed for fencing. With its functional and informational diversity it sets new benchmarks in the ease of use. The numerous innovative features make it easier to handle and carry-out even big competitions without any problems.

The **FMA21** is certified for all three weapons – foil, epee, sabre – according to FIE regulations.

The central unit of **FMA21** is an all-in-one computer with touch screen for optimal display and control of all relevant information and offers optimal possibility to connect peripheral devices (large-format screens, result management, video refereeing etc.)

A simple user interface and a clear structure of all information displayed on the monitor guarantee the best overview at any time.

The **FMA21** is controlled with its touch screen or with an IR remote control (offering a considerably improved operating distance compared to previous models).

With the integrated USB interface changes in software (FIE regulation updates, firmware updates, new functions etc.) can be updated at any time without chip changing. The **FMA21** always adapts to the latest requirements.

Together with the appropriate stand\* and the attachable repetition lights\* the FMA21 currently is the most powerful and innovative scoring machine on the market.

\* optional equipment

### 2 Performance features

**FMA21** offers features that are not available with any other scoring machine until now.

#### 2.1 *General performance features*

- Intuitive user interface and help functions via touch screen (different languages available)
- Profile management with individual setting of many parameters and display options
- With using the profiles the layout of design elements as well as the configuration of the serial ports can be setup
- Indication of names, pictures and national flags of fencers
- Indication of video requests still to be demanded
- Indication of up to 15 red cards and of black card
- Possibility to set the remaining fight time accurate to the second (for example after an operating error)
- Saving the last four fight times and scores with the possibility to recall this results via touch screen (for example after an operating error, reset by mistake etc.)
- Possibility to request medical or technical help at DT (directoire technique) directly from the piste via touch screen (when LAN connection with result management network are available)
- Remote configuration and monitoring of all devices in the hall by DT (when LAN connection with result management network are available)
- Three special modes for wireless fencing for an optimal connection with “Wireless 2000”
- Possibility to update and upgrade without changing chip (via USB connection)
- Intelligent repetition light control
- In connection with the stand and depending on setup (with one or two scoring machines), one pair of repetitions lights can either display the signals of one scoring machine (on front and rear side) or the signals of both scoring machines (on the respective front side).

- Wear-free LED technology (no bulbs). Therefore replacing lighting elements is not necessary.
- Side inverting (for example to display the content of an opposite scoring machine) is possible without changing light calottes.
- Voltage supply with 12 V via external medical power supply unit to connect to 100 V – 240 V
- Up to three power sources can be simultaneously connected to the scoring machine
- Data connection of UPS (uninterrupted power supply) via RS232 or RS422 interface to avoid voltage breakdown and loss of data

## **2.2      *The user interface (display with touch screen)***

The 22" TFT touch screen (55,8 cm) which can also be operated when wearing gloves is able to show all relevant fight information.

With pre-defined and individually generated profiles sort and extend of the displayed information can be defined individually.

The following information is available:

- Valid and invalid hits via lamps independent of the monitor
- Names, pictures and national flags of fencers (in connection with result management system, for example Ophardt)
- Score
- Fight time
- Fight number
- Number of piste
- Yellow, red (up to 15) and black card
- Number of video requests still available(in connection with video refereeing; for example SwissTiming)
- Yellow anti-blocking lamp (flore) as well as red ground lamp (epee)
- Multilingual user interface

## **2.3      *Additional equipment and options***

### **2.3.1    System table stand FMA21-STS1 / FMA21-STS2**

To attach scoring machine and repetition lights. The system table stand can be mounted directly on a table using a mounting bracket. The system table stand can hold one (single piste, FMA21-STS1) or two FMA21 (double piste, FMA-21-STS2).

### **2.3.2    System floor stand FMA21-SBS1 / FMA21-SBS2**

Same properties as system table stand but system floor stand is positioned directly on the floor.

### **2.3.3    Table stand FMA21-TSF**

Simple stand to setup the FMA21 on a table. Repetition lights can not be connected.

### **2.3.4    Repetition lights FMA21-HL**

Signal lights for displaying hits.

The repetition lights are attached to the stand (FMA21-STS or FMA21-SBS) without any additional cable connection.

Each stand only needs one pair of repetition lights. The intelligent control system detects whether one or two scoring machines are connected.

With one scoring machine connected the repetition lights show the hits on the front and rear side. If two scoring machines are connected the hits are shown on the respective side of the repetition lights.

### **2.3.5 Transport case FMA21-TK**

Extremely robust flight case for transport and compact storing of FMA21 and accessories.

### **2.3.6. Transport case „double“ FMA21-TK2**

Mobile flight case to transport all material required for a double piste (2 scoring machines FMA21, 1 stand, 1 pair of repetition lights, 4 reels, 4 connecting cables and 1 UPS).

### **2.3.7 Connecting cable FMA21-KK**

Connecting cable for simultaneous connection of scoring machine with power supply and/or battery.

### **2.3.8 UPS FMA21-USV**

Uninterrupted power supply unit for FMA21

### **2.3.9 Network switch 5 port 1 GBit/s**

To connect up to 5 FMA21 in a network (LAN)

### **2.3.10 Network cable on reel Cat6, 50 m**

### **2.3.11 Network cable CAT6, 2 m**

### **2.3.12 Serial cable, 3-pin with Neutrik XLR connector for master/slave operation via RS485**

### **2.3.13 Serial cable, 3-pin with SUB-D 9-pin for master/slave operation via RS232**

### **2.3.14 Serial cable, 3-pin with SUB-D 9-pin for master/slave operation via RS422**

### **2.3.15 Remote control cable, 5 m**

### **2.3.16 Remote control cable, 30 m**

### **2.3.17 allstar Cyrano server**

### **2.3.18 allstar app server**

### **2.3.19 FMA21 slave software**

### **2.3.20 FMA21 pager system**

### **2.3.21 Cleaning cloth for touch screen**

### 3 Overview of control and display elements

#### 3.1 Front side of FMA21



Fig: front side of FMA21 (standard profile)

No.	Functional description
<1>	Lamps
<2>	Operating lamp
<3>	Touch screen (screen) According to the selected profile the touch screen can show different elements.

### 3.2 Operating elements and connectors on back side of FMA21

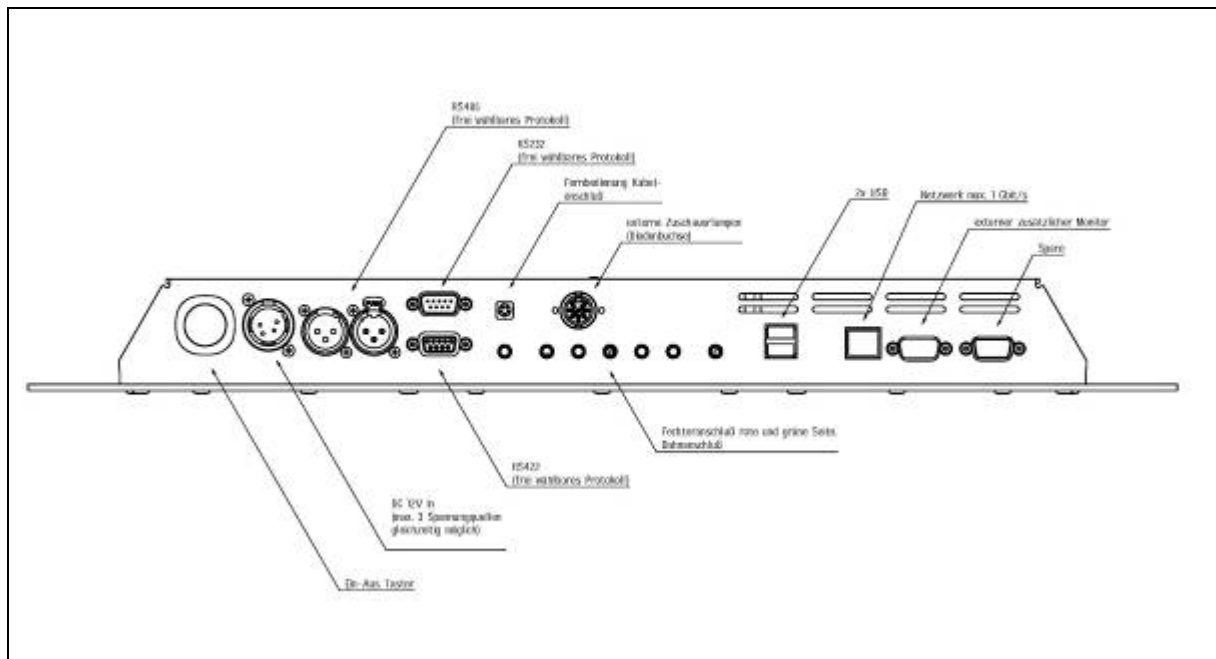

Fig: back side of FMA21

No.	Functional characteristics
<1>	<b>System connection</b> To connect FMA21 with a stand and repetitions lights.
<2>	<b>On/off switch</b> Switch-on: Keep button pressed for approx. 1 sec until operating lamp lights up. Switch-off: Keep button pressed for approx. 5 sec until operating lamp lights up blue.
<3>	<b>Power connector (DC 12V)</b> Please only use the original power supply (included in delivery)
<4>	<b>RS485 interfaces* via XLR 3-pin male and female</b> Preset for communication with allstar peripheral devices (repetition lights and running time for finales, slave scoring machines, podium lamps, etc.) Further protocols can be selected individually.
<5>	<b>RS232 interface* via sub-D 9-pin male</b>
<6>	<b>RS422 interface* via sub-D 9-pin female</b> * Transmission protocols and standards can be individually selected on these three interfaces. For example for data exchange with large-format screens (KABCOM, Swiss Timing), video refereeing and others.
<7>	Connector for wired remote control
<8>	Connector (analogue) for external repetition lights (7-pin diode socket)
<9>	Connector 3-pin: fencer red side
<10>	Connector 3-pin: fencer green side
<11>	Connector: piste
<12>	<b>2 x USB</b> Firmware and other software (FIE regulation updates, new functions etc.) can be easily updated via USB interface without chip changing
<13>	<b>Ethernet (LAN) via RJ45 (max. 1 Gbit/s)</b> Connection to result management, remote configuration and monitoring of FMA21, network-based update of firmware and possible connection of slave scoring machines.
<14>	<b>VGA connector</b> To connect an external monitor/large-format screen
<15>	Type plate with technical connection data and device number



### 3.3 Display elements of touch screen in standard profile (stand-alone operation)

Is the FMA21 used as single device – like previously common devices are used – and has no network connection to a result management system (Ophardt, EnGarde, Mask, ...) the standard profile can be selected. The standard profile shows the following display elements on the screen:



Fig: front side of FMA21

<4>	Piste number
<5>	Chronometer (fight time)
<6>	Yellow anti-blocking lamps (foil) or red ground lamp (epee)
<7>	Score
<8>	Fight number Individual competition: display of fight segment (1 - 3) Team competition: display of fight number (1 - 9)
<9>	Menu bar (see point 3.5)
<10>	Yellow cards
<11>	Red cards (up to 15 red cards can be displayed)
<12>	Black card
<13>	Video requests Shows the possible video requests available for the fencer (in connection with video refereeing system, for example Swiss Timing)

### 3.4 Additional display elements of touch screen in „Cyrano profile“ and in „Cyrano-Ophardt profile“

The Cyrano protocol manages the communication between scoring machine and result management system (Ophardt, EnGarde, Mask, ...). It is one of the standards recommended by the FIE. **FMA21** is connected with the result management system LAN via RJ45 network interface.

Through the network **FMA21** receives information from the result management system (RMS) such as fencers' names, nationality, etc. Reversely the FMA21 sends fight information to the RMS (score, time, cards, etc.).

### Additional display elements available with „Cyrano“ profile

Apart from the display elements described in standard profile the Cyrano profile is able to show additional information (depending on the result management system used).

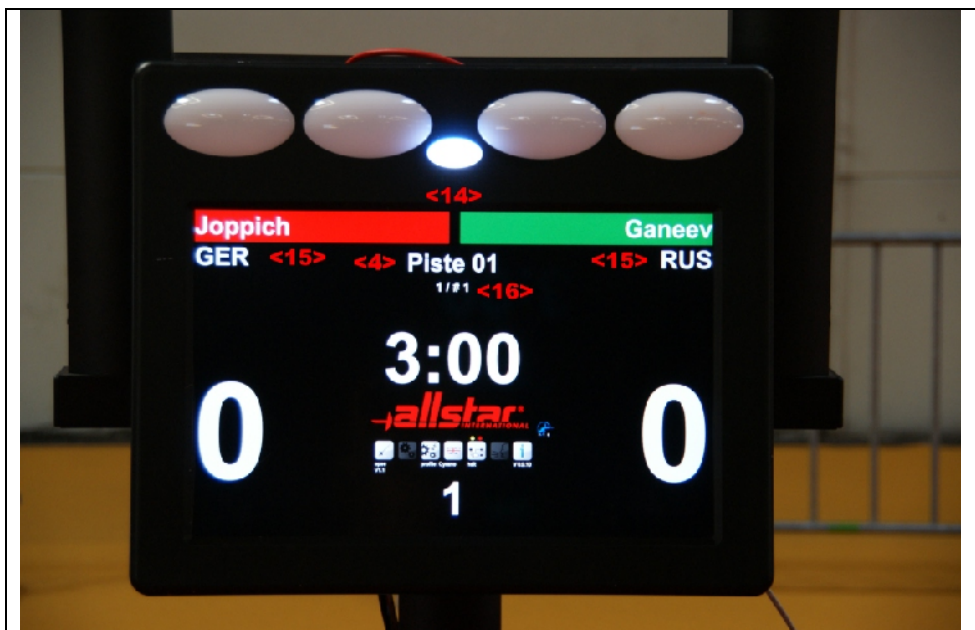

Fig: Display elements Cyrano profile

<4>	Piste number and/or name as text (for example finale podium, piste rouge, ...)
<14>	Name of fencers
<15>	Nationality of fencers
<16>	Indication of round or tableau

**Additional display elements available with „Cyrano with Ophardt team“ profile (individual)**

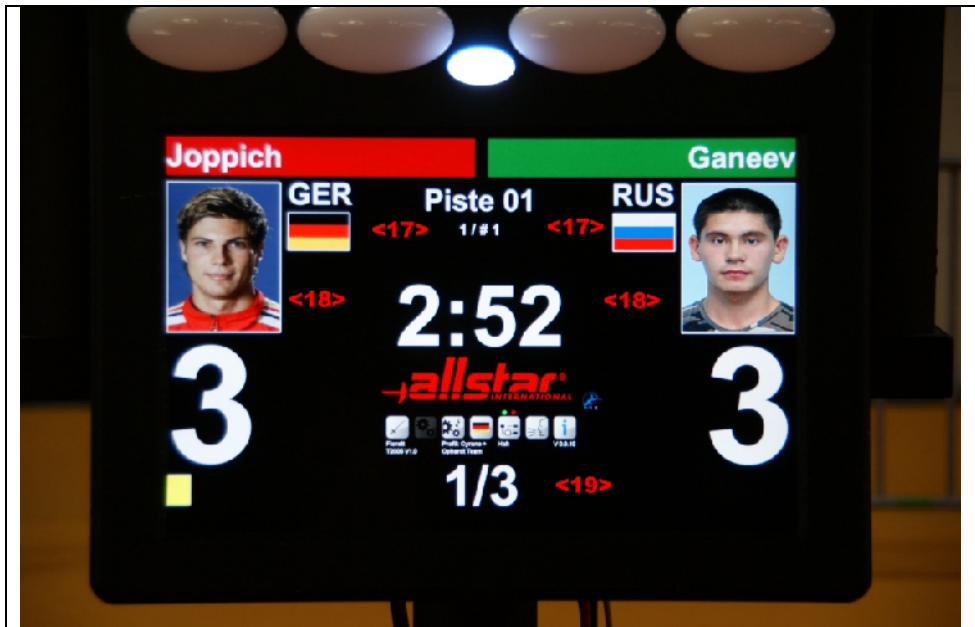

Fig: Display elements in Cyrano with Ophardt profile – individual competition

<17>	National flag of fencers
<18>	Pictures of fencers
<19>	Round and fight number

**Additional display elements available with „Cyrano with Ophardt team“ profile (team)**



Fig: Display elements in Cyrano with Ophardt profile – team competition

<19>	Team name and fencer's name
<20>	Score of team fight
<21>	Score of current fight

## 3.5 Menu items

### 3.5.1 General operation

By touching the touch screen the menu elements are activated and possible submenus are opened. In some cases the selection has to be confirmed by pressing

the OK button  .

The back button  is used to leave the function without new selection.

### 3.5.2 Menu structure



#### **OPERATING MODE**

Selecting operating mode of scoring machine.

When switching on **FMA21** the previously selected operating mode is active. By touching the current operating mode all available modes are displayed and can be selected by touching.



Epee

Foil acc. to current FIE regulation T2005

Sabre acc. to current FIE regulation T2005

„Wireless“

This mode is required to connect the wireless scoring machine “Wireless 2000” made by STM



#### **SETTINGS**

This menu is currently deactivated. It will be available with one of the next software updates.



#### **QUICK SETTINGS**

By touching the button “Quick settings” all available settings are displayed and can be selected by touching it.



#### **Auto reset**

Auto reset causes the automatic clearing of the lamps after approx. 2 sec. A green highlighted button shows the activated setting.

If auto reset is not activated the lamps have to be cleared manually with remote control.



#### **Auto stop**

Auto stop automatically stops the chronometer if the scoring machine determines a hit and one of the lamps lights up.

A green highlighted button shows the activated setting.

If auto stop is not activated the chronometer has to be stopped manually by using the remote control.



#### **All Reset**

Resets the display (chronometer, score, fight number, cards, etc.) to the initial values or to “0”.



#### **Dice**

Offers the same functionality as the “Dice” button on the remote control (see remote control)



#### **Profile**

Selection of required scoring machine profile. With these profiles presettings can be activated:

- „Standard“ (stand-alone): scoring machine works like a conventional device
- „Cyrano“: scoring machine is connected to a Cyrano compatible RMS via network and is able to show additional information (names, nationality)
- „Cyrano with “XXX”“: scoring machine is connected to RMS made by “XXX” via network and is able to show additional information (names, nationality, pictures, round tableau, etc.)
- Slave (Net): The scoring machine is connected to a master scoring machine via network. The display exactly shows the display of the master scoring machine.
- Slave (Net) inverted: The scoring machine is connected to a master scoring machine via network. The display inversely shows the display of the master scoring machine. This becomes necessary if the slave scoring machine is mounted on the backside of the master scoring machine.
- Slave (RS232, RS422, RS485): The scoring machine is connected to a master scoring machine via serial interface. The display shows information of the master scoring machine.

**Attention:** Depending on the selected protocol the appearance of the display may vary or information can possibly not be communicated and displayed.

Please find further instructions on setting up several FMA21 in the enclosure. (Network setup with FMA21)



#### **Assign remote control**

If this function is activated the scoring machine can be programmed for any allstar or Uhlmann FB03 remote control. Each scoring machine is able to handle up to five different remote controls. Please see point 4.1.3 for closer information.



#### **Standby/Off**

By touching this button a submenu will open up which can be used to switch the FMA21 to standby mode or to switch it off.

In standby mode the lamps as well as the acoustic beeper are not active. The screen is dark and shows “standby” (or a predefined standby picture). By touching the screen in standby mode the previously set operating mode (for example foil) is re-activated. In connection with the allstar-app-server (special option) individual standby pictures (for example sponsors' logos) can be transferred and displayed.

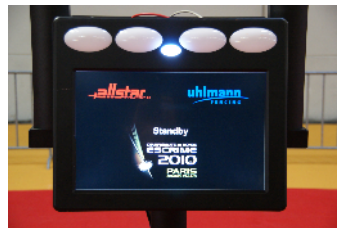

Depending on the profile a password (standard user password) might be necessary to switch off the scoring machine.



#### **Back**

Closes the current menu.



### **LANGUAGE SELECTION**

Selection of language for user interface.

German



English



French

Chinese – currently deactivated

Russian – currently deactivated

Further languages will be delivered with future updates.



## **NETWORK**

The network menu provides functions to control the different steps of the communication between FMA21 in a Cyrano network and a result management system (RMS).

All functions are also available with the remote control (see remote control).



### **Start**

Activates the currently displayed fight sent by RMS. After activation no modifications can be made by RMS any more.



### **End (validation)**

Sends the displayed results to the RMS for storage.

The RMS checks the results and saves them. If the results are not correct a message will appear. The results have to be corrected and sent again. If results are OK a possibly next fight will be sent by the RMS.



### **Next**

Requests the next fight. This function is only available as long as the currently displayed fight is not activated. Serves to correct already saved fights.



### **Previous**

Requests the previous fight. This function is only available as long as the currently displayed fight is not activated. Serves to correct already saved fights.



### **Tableau**

Shows the tableau during rounds (at the moment only in cooperation with Ophardt result management system). This functionality depends on the RMS.

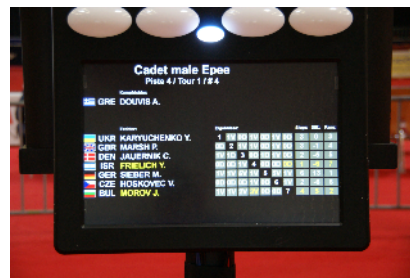

### **Back**

Closes the current menu.



## **HELP**

This menu is only available if **FMA21** is installed in a network and the allstar-app-server or allstar Cyrano server is started with the corresponding application or if this function is supported by the RMS.



### **Technician call**

Press this button to request technical help. A message is sent to the allstar-app-server in the DT (directoire technique) to ask for technical support on this piste.

In addition, this message can be sent directly to the technician's pager (special option).

If repetition lights (FMA21-HL, special option) are attached to the FMA21 these will blink in orange colour to enable the technician to find the affected piste shortly in the fencing hall.



#### **Medical call**

Press this button to request medical help. A message is sent to the allstar-app-server in the DT (directoire technique) to ask for medical support on this piste.

In addition, this message can be sent directly to the doctor's pager (special option).

If repetition lights (FMA21-HL, special option) are attached to the FMA21 these will blink in blue colour to enable the doctor to find the respective piste shortly in the fencing hall.



#### **Call for DT**

Press this button to request help from the DT. A message is sent to the allstar-app-server in the DT (directoire technique) to ask for DT support on this piste.

In addition, this message can be sent directly to a pager (special option).

If repetition lights (FMA21-HL, special option) are attached to the FMA21 these will blink in violet colour to enable the DT to find the respective piste shortly in the fencing hall.



#### **INFO**

This menu item includes the online help function, the version number as well as the update function of **FMA21**.

##### Version number:

This point shows the version numbers of all integrated and connected modules. This information is mainly required for support purposes.

##### Update:

FMA21 can be updated with latest regulations and functional upgrades. For this, you may receive an update file.

Please only use update files which are provided by allstar. Each FMA21 needs its own update file. Only use the update file that is provided for this particular FMA21. It might be necessary to enter a password for the update.

##### Procedure:

Copy the update file on an empty USB flash drive, put this in one of the USB connectors and wait approx. 10 s.



By touching the info button the scoring machine checks if an update file exists on the flash drive. If a complete and error free update file is available the right upper field shows "update". By touching this field the update process is started. After the update has been successfully completed the FMA21 will switch off. All new functions will be available after restarting the scoring machine. The update process may take several minutes.

##### Caution:

Never switch off the FMA21 as long as updates are processed. Non-observance may lead to damages. A resulting repair is not included in warranty.

The complete functionality will only be available with one of the next software updates.

### 3.6 Direct operation with touch screen

By touching certain display elements on the touch screen, settings can also be changed. The selection may have to be confirmed with OK . With „Cancel“  the function can be left without any new selection. Several settings can only be changed if the chronometer is stopped.

#### Setting of different parameters:

##### 3.6.1 Chronometer

If the chronometer is stopped a chronometer setup menu can be opened by touching the chronometer shown on screen. The remaining fight time (for example after an operating error) can be entered to the second with the shown virtual numeric keyboard. Confirm your settings with OK or Cancel.

On the right side of the virtual keyboard you will find four fields showing time and fight scores as well as the issued warning cards which were automatically stored with the last four chronometer stops. By touching one of these fields you return to the automatically stored setting.

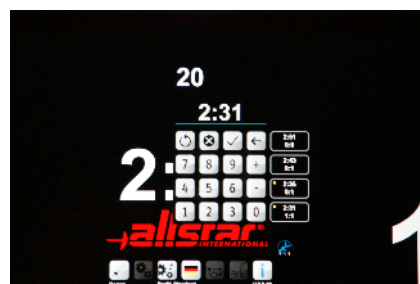
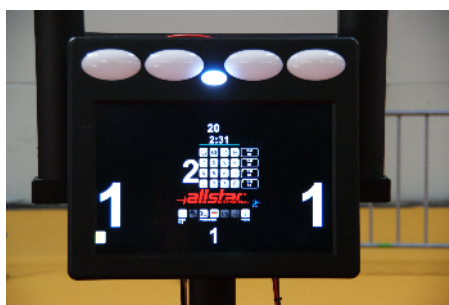

This function is only available with touch screen but not with remote control FB03.

##### 3.6.2 Score

By touching the score a virtual keyboard opens with which the current score can be entered. First of all, touch the number which should be changed, then you can enter the requested number and confirm.

Changing the score can also be done with remote control FB03.



##### 3.6.3 Piste number/slave number

By touching the piste number a virtual keyboard opens with which a new piste number can be entered. Depending on the preset profile a password (standard user password) might be necessary to change the piste number.

Furthermore, this menu in slave profile is used to set the slave number. Please find further information on operating several FMA21 in a network in the enclosure (network setup with FMA21).



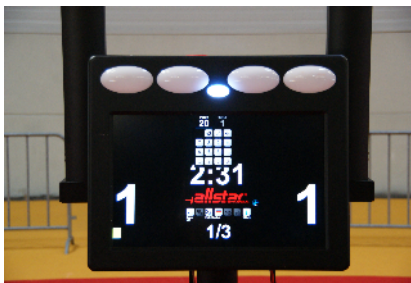

This function is only available with touch screen but not with remote control FB03.

### 3.6.4 Fight number

Depending on the preset profile changing the fight number may not be possible and is given by the RMS.

### 3.6.5 Warning cards

By touching the display area of the cards (the area under the score) a new window opens with which yellow, red and black cards as well as video requests can be changed. Touch the card that should be changed, a cyan coloured line under the card shows which card is currently selected. By touching + or – the requested number of cards can be setup.

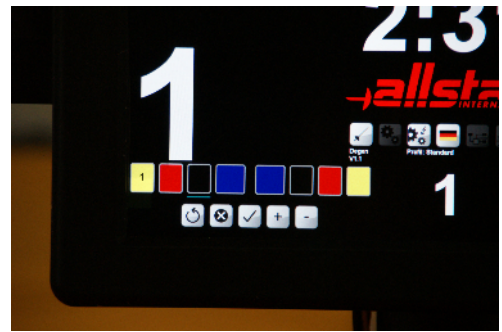
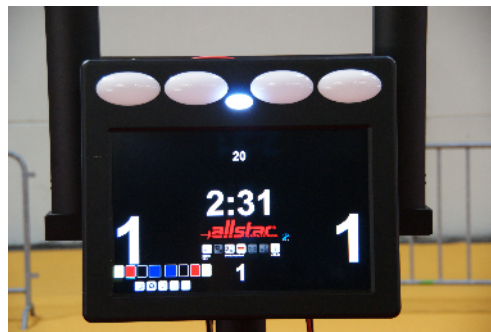

Changing cards and video requests can also be done with the remote control FB03 (see below).

# FB 03

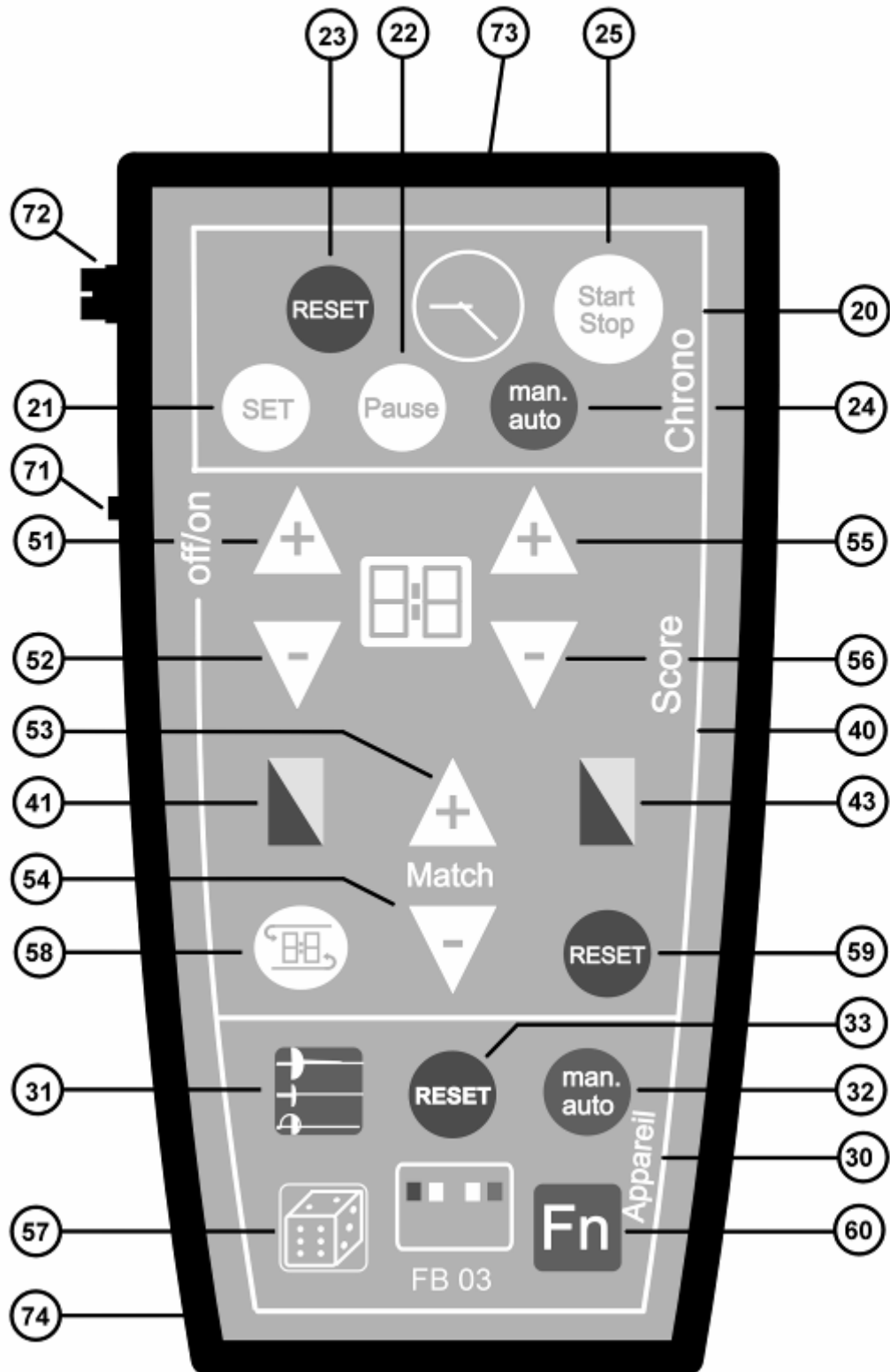

### 3.3 Remote control FB03a

No.	Functional characteristics
<20>	<b>Keypad for chronometer</b>
<21>	<b>SET:</b> (only possible with time stopped) Default time selection. By continuously pressing SET the fight time can be adjusted by minutes.
<22>	<b>PAUSE:</b> (only possible with time stopped) Pause time is displayed in yellow colour. To start pause time press START <25>. The pause time can be stopped at any time by pressing STOP <25>. With RESET <23> you get back to the last fight time. If pause time runs to 0:00 a acoustic signal will be given. The time goes back to the last fight time or default time automatically. By continuously pressing PAUSE the default pause time can be adjusted by minutes. Pause times from 1 minute to 10 minutes can be set.
<23>	<b>RESET:</b> (only possible with time stopped time) Resetting time to default fight time after termination of a fight.
<FN><23>	<b>EXIT MATCH:</b> (only available in „Cyrano“ or “Cyrano + xxx” profile): End fight without saving the results.
<FN>+<24>	<b>MAN/AUTO:</b> <i>only active if 'FN' &lt;60&gt; is pressed simultaneously.</i> Switching between automatic (by hit) and manual chronometer control. The set mode is displayed in the quick settings menu.
<25>	<b>START/STOP:</b> Pressing this button once starts the time. Pressing this button again stops the time.
<FN>-<25>	<b>START MATCH:</b> (only available in „Cyrano“ or “Cyrano + xxx” profile): Activate fight, end fight with storing the results at RMS.
<30>	<b>Keypad for scoring machine functions</b>
<FN>+<31>	<b>Selecting operating mode:</b> <i>This button only works if you simultaneously press 'FN' (&lt;60&gt;).</i> By repeated pressing of this key combination the device changes between epee, foil and sabre. The selected weapon is shown in the main menu.
<FN>+<32>	<b>MAN/AUTO:</b> <i>This button only works if you simultaneously press 'FN' (&lt;60&gt;).</i> Switching between automatic and manual clearing of lamps. The set mode is displayed in the quick settings menu.
<57>	<b>DICE:</b> random generator to determine the priority.
<60>	<b>FN (function):</b> In combination with particular keys on the remote control special functions can be selected. This avoids operating errors with important functions.
<33>	<b>RESET:</b> Manual clearing of the lamps.
<40>	<b>Keypad for warning cards and score</b>
<41>	Yellow or red card left fencer. Pressing once sets a yellow card, pressing again adds one red card. Each additional pressing of this button adds another red card (max. 15 in total).
<43>	Yellow or red card right fencer. Pressing once sets a yellow card, pressing again adds one red card. Each additional pressing of this button adds another red card (max. 15 in total).
<51>	Score left side + 1
<FN><51>	Number of video requests left side +1
<52>	Score left side - 1
<FN><52>	Number of video requests left side -1
<53>	Increase fight number by 1.
<FN><53>	Request next fight (only available with RMS)
<54>	Decrease fight number by 1.
<FN><54>	Request previous fight (only available with RMS)
<55>	Score right side + 1
<FN><55>	Number of video requests right side +1
<56>	Score right side - 1
<FN><56>	Number of video requests right side -1
<58>	<b>CHANGE:</b> changing sides of fencers
<FN><58>	Start procedure of inserting spare fencer. (only available wit RMS and team competitions).
<59>	<b>RESET:</b> Reset of score, fight number and warning cards.
<71>	On/off switch of remote control
<72>	Connector for connection cable of remote control. If the remote control is connected to the remote control connector of <b>FMA21</b> by cable the infrared emission is deactivated.
<73>	Infrared transmitter unit: To provide the correct function of the remote control please take care that there is no obstacle between transmitter unit and the receivers in <b>FMA21</b> .
<74>	Battery box: on the back side of the remote control

To avoid unintended operating errors some important functions of the remote control (for example changing weapons) are only available when pressing the key combination **<Function>+<FN>**.  
To use the remote control it has to be switched on (ON switch <71>) and to save battery it should be switched off after operation (OFF).

## 4 Operation:

### 4.1 Connecting the device:

The device can be operated with mains – power supply is included in delivery – or with a combination of battery (12 V, 60 AH) and mains. With combined operation – according to FIE regulations – ALL functions of the scoring machine are also available during power breakdown.

A combined connecting cable (special option FMA21-KK) to simultaneously connect to power supply and to battery can be ordered optionally. Alternatively, an optionally available UPS can be used. With this UPS a mains breakdown can be handled without connecting a battery.

#### 4.1.1 Mains operation:

- Check whether the mains supply voltage conforms to the voltage mentioned on the provided power supply – see type plate (90 – 260 VAC).
- Plug in power supply at the top side <3> of FMA 21 .
- Connect power supply to mains supply.
- Switch on power switch of power supply (green LED must be on).
- Keep power switch <2> pressed until the operating lamp flashes green. Depending on the previously selected operating mode the lamps may be immediately on.

#### 4.1.2 Combined mains/battery operation:

- Check whether the mains supply voltage conforms to the voltage mentioned on the provided power supply (see type plate).
- Plug in combined plug at the top side of the device <3>.
- Connect power supply to combined power cable.
- Connect combined power cable to battery (consider correct polarity). In case of reverse connection the device will not work properly due to reverse voltage protection.
- Switch on power switch of power supply (green LED must be on).
- Keep power switch <2> pressed until the operating lamp flashes green. Depending on the previously selected operating mode the lamps may be immediately on.

#### 4.1.3 Activating remote control channels:

All scoring machines of type **FMA21** provide the remote control management A.R.C. (auto remote control). Therefore, **FMA21** can be programmed to up to five allstar remote controls (FB03a).



#### Procedure:

- Switch on **FMA21** and remote control FB03a.
- Activate menu “remote control” at touch screen of FMA21.
- Press any key of the remote control (except green FN key) and direct it towards the operating lamp <2> on the front side of the scoring machine.
- The upper part of the **FMA21** “remote control” menu shows channel number and key number of pressed key on the remote control.
- Touch a free field in the list of the saved remote controls. A cyan coloured line marks the currently

selected field. By pressing  the currently shown remote control is taken over to the next empty field. In this way, up to 5 remote controls can be assigned to FMA21.



- By pressing  the currently marked remote controls can be deleted from the list.
- Finally confirm with OK to save all changes.

All saved remote controls remain available after switching off and again switching on the device.

#### 4.1.4 Master/slave operation:

Several scoring machines can be connected to each other by using the serial interfaces of FMA21 or via network. In case of an connection via RS232 or RS422 interface maximum one slave can be connected with one FMA21 master scoring machine. With a connection via RS485 or network up to eight slave scoring machines can be connected to the master.

Depending on the connection type different information is transmitted to the slave scoring machines. Via the serial interfaces typically only time, lamps and score information are transmitted. Whereas with a network connection all available information is transmitted. With the connection via network some inputs made at the slave scoring machines can also be transmitted to the master scoring machine.

The different operating modes can be set with the profiles or the interface settings.

#### Approach (network):

- Make sure that master as well as slave scoring machine are connected to the network.



- Activate menu quick settings



- Select profile settings
- Choose „Slave (net)“ (slave is an exact copy of master) or „Slave (net) inverted“ (slave is inverted copy of master).
- Set piste number of master at slave scoring machine and assign a consecutive slave number for the field “Slave #”.
- To change the settings a password (standards user password) must be entered.
- For a successful implementing of the scoring machines in a network please read the details in enclosure.

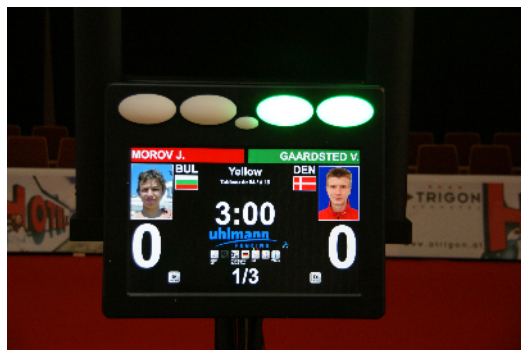

Master scoring machine

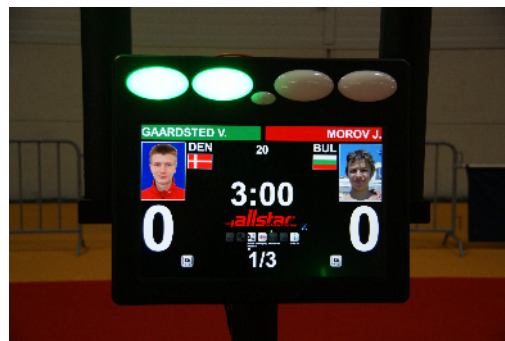

Inverted slave scoring machine on back side

Some functions will only be available with one of the next software updates.

## **4.2 Use of remote control**

The **FMA21** is delivered with an infrared remote control by default. Before using it, it has to be registered for FMA21. Up to 5 different remote controls can be registered at the same time.

Please consider that the correct functionality of an infrared remote control is only provided if there is no obstacle between the transmitter unit of remote control and the receiver units in **FMA21**. The operating distance of the infrared remote control considerably reduces if the receiver units are exposed to direct sun or extreme artificial light. The receiver units are located in both outer lamps as well as in the operating lamp.

To operate the remote control a battery (9 V block) is required. A short acoustic signal as well as a short green flash up of the operating lamp follow each activity with the remote control.

Signals of non registered remote controls are signalled by a short red flash up of the operating lamp. Does the operating lamp of the FMA21 not show any signal the battery of the remote control may have to be changed or the distance between remote control and receiver unit is too big.

The remote control can alternatively be connected directly to the FMA21 with an optional cable (connector <7>). Remote controls connected with cable must not be registered at FMA21, these work independently of the preset channel number.

Caution: Remote controls connected with cable do also need a battery with enough energy.

## **4.3 Changing battery of remote control**

If battery capacity declines the operating distance of the remote control is getting smaller and finally it will not work any more. As soon as the decline of the operating distance or the not reliable function is recognised the battery of the remote control has to be replaced.

- Unlock and open cover of battery case on the back side of the remote control.
- Replace old battery by new one.
- Close battery case.

Using rechargeable batteries is not recommended.

## **4.4 LED technology used for lamps <1> of FMA21 and for repetition lights**

All lamps have LEDs inside which are maintenance-free and offer a very long life-time. All LEDs have a redundancy of at least 3, i.e. when one LED breaks down the lamps will still work and will only be slightly darker. Therefore, changing lamps is not necessary any more.

## **4.5 Operation with different supply voltage**

With the provided power supply FMA21 can be operated with supply voltage from 100 to 240 VAC at a frequency of 47 – 63 Hz. Please **only use the provided power supplies !!!**

## 5 Maintenance and service

Should there be any questions or should any error occur which cannot be handled by yourself we are looking forward to receiving your call or e-mail.

In general, the device must only be opened and repaired by authorised professionals. Before sending in the device for repair please get in touch with your agency or directly with **allstar**. Supposed errors can often be cleared with a telephonic advice.

### Important information regarding error analysis:

For questions please always indicate device type and number (for example FMA21 and 2010 xxxx) written on the type plate. The type plate can be found on the backside above or under the holder of the remote control. This information can also be found in the help menu.

**Cleaning of touch screen only with microfibre cloth and a drop of water.  
Never use any detergents and make sure that liquidity does not enter into the device.**

**Before starting up the device leave it at least 2 hours in the corresponding room to get used to the temperature.**

**Never transport the FMA21 in lying position. The vibrations during transport may break the glass panel. We are pleased to offer professional transport cases (FMA21-TK, FMA21-TK2) which protect the FMA21 very well during transport.**



## Warranty:

The FMA21 is granted a one year warranty from date of invoice for spare parts and work. Possible transport costs are on customer's account.

Warranty does not include:

- expendable materials (lamps, batteries etc.)
- improper repair by external parties
- improper handling
- damage by accident (break by falling down or similar)
- damages caused by connecting non-authorised accessory devices
- damages caused during transportation

### Scoring machine FMA21

Trendsetting technology, Made in Germany



allstar Fecht-Center GmbH & Co. KG  
Carl-Zeiss-Strasse 61  
72770 Reutlingen/Germany  
Tel. +49 7121 9500-0  
Fax +49 7121 9500-99  
info@allstar.de  
<http://www.allstar.de>

# Contents

1	Introduction .....	4
2	Performance features .....	4
2.1	General performance features .....	4
2.2	The user interface (display with touch screen) .....	5
2.3	Additional equipment and options .....	5
3	Overview of control and display elements .....	7
3.1	Front side of FMA21 .....	7
3.2	Operating elements and connectors on back side of FMA21 .....	8
3.3	Display elements of touch screen in standard profile (stand-alone operation) .....	9
3.4	Additional display elements of touch screen in „Cyrano profile“ and in „Cyrano-Ophardt profile“ .....	9
3.5	Menu items .....	12
3.6	Direct operation with touch screen .....	16
3.3	Remote control FB03a .....	19
4	Operation: .....	21
4.1	Connecting the device: .....	21
4.1.1	Mains operation: .....	21
4.1.3	Activating remote control channels: .....	21
4.1.4	Master/slave operation: .....	22
4.2	Use of remote control .....	23
4.3	Changing battery of remote control .....	23
4.4	LED technology used for lamps <1> of FMA21 and for repetition lights .....	23
4.5	Operation with different supply voltage .....	23
5	Maintenance and service .....	24
	Warranty: .....	25
	Contents .....	26
	Enclosure A : FMA21 operated in a network .....	28
1.	Introduction .....	28
2.	Interfaces .....	28
2.1	RS 232 .....	28
2.2	RS 422 .....	28
2.3	RS 485 .....	29
2.4	Network (LAN) .....	29
2.3	USB .....	29
3.	Protocols .....	30
3.1	Protocol Kabcom .....	30
3.1.1	Properties .....	30
3.1.2	Transmitted fields .....	30
3.1.3	Telegrams .....	30
3.2	Protocol Swiss Timing .....	30
3.2.1	Properties .....	30
3.2.2	Transmitted fields .....	30
3.2.3	Telegrams .....	31
3.3	Protocol Swiss Timing 2.0 .....	31
3.3.1	Properties .....	31
3.3.2	Transmitted fields .....	31
3.3.3	Telegrams .....	31
3.4	Protocol internal bus .....	32
3.4.1	Properties .....	32
3.4.2	Transmitted fields .....	32
3.5	Protocol internal bus V19 .....	33
3.5.1	Properties .....	33

3.5.2 Transmitted fields .....	33
3.6 Protocol allstar fencing link .....	33
3.6.1 Properties .....	33
3.7 Protocol Cyrano .....	33
3.7.1 Properties .....	33
3.7.2 Transmitted fields .....	33
3.7.3 Telegrams .....	34
3.8 allstar protocol extension .....	35
3.8.1 Properties .....	35
3.8.2 Transmitted fields .....	35
3.9 Which protocols with which interfaces .....	36
4. Network connection (LAN).....	37
4.1 Network protocols .....	39
4.2 Network setup with FMA21 .....	41
4.3 State machine with Cyrano .....	44
4.4 allstar Cyrano server .....	47
4.5 Network tips .....	48

# Enclosure A : FMA21 operated in a network

## 1. Introduction

This manual gives an overview of the interfaces and the corresponding protocols available for FMA21. Basic technologies to integrate FMA21 into a network are explained. Furthermore, the structure of different integration possibilities, tips and tricks as well as possible causes of faults are shown.

## 2. Interfaces

Interfaces are used to connect several systems to each other. The choice of the right interface for the corresponding application depends on different parameters, for example distance, sort of protocol and bit rate. Not all protocols available for FMA21 are available with each interface.

### 2.1 RS 232

The RS232 interface is used to transmit information to other systems. This interface is galvanically separated and therefore offers a maximum protection against influences by connected systems. The RS232 interface offers the following properties:

- SUB-D connector, male; 9-pin
- Pin configuration: 2: RxD, 3: TxD, 5: GND
- Bit rates up to 115 kbit/s, no hardware handshake
- Different protocols available (see chapter 3.9)

### 2.2 RS 422

The RS422 interface is used to transmit information to other systems. This interface is galvanically separated and therefore offers a maximum protection against influences by connected systems. The RS232 interface offers the following properties:

- SUB-D connector, female; 9-pin
- Pin configuration: 1: RxD-, 2: RxD+, 3: TxD-, 4: TxD+, 6: GND, 7: GND
- Bit rates up to 115 kbit/s, no hardware handshake
- Different protocols available (see chapter 3.9)

## 2.3 RS 485

The RS485 interface is used to transmit information to other systems as well as to receive data from other systems. As RS485 is a bus interface it can be either master (sender) or slave (receiver). This functionality allows to connect more than two devices to this bus. Profiles configure whether the interface is used as master or slave.

The interface is typically used to connect previous scoring machines of the FMAxx series or other allstar peripheral devices (large repetition lights or large-format displays showing time for finales, etc.).

This interface is also galvanically separated and therefore offers a maximum protection against influences by connected systems. The RS785 interface offers the following properties:

- 2 pieces 1:1 connected XLR connectors, 1 x male and 1 x female
- Pin configuration: 1: GND, 2: RxD- / TxD-, 3: RxD+ / TxD+
- Bit rates up to 115 kbit/s, no hardware handshake
- Different protocols available (see chapter 3.9)

## 2.4 Network (LAN)

By using the LAN interface several FMA21 devices can be integrated into a network. Through this network information can be exchanged with a common server, result system server or between the FMA21 devices in the network. The functionality is also configured with profiles. Further information on how to operate FMA21 in a network can be found in chapter 4. The existing network interface offers the following properties:

- RJ45 connector 8-pin
- 2 LEDs in socket: green (activity), yellow (connection)
- Pin configuration : 1: D3-, 2: D3+, 3: D2-, 4: D1-, 5: D1+, 6: D2+, 7: D0-, 8: D0+
- Bit rates up to 1 Gbit/s
- Different UDP and TCP protocols possible (see chapter 3.9 and 4)

## 2.3 USB

FMA21 offers two USB 2.0 interfaces. Currently, these are only used to transfer update files. In the future, this interface shall be used to transfer information as well.

### 3. Protocols

To communicate between different systems transmission protocols are used. For FMA21 lots of different protocols are available. Not all protocols are available with each interface. An assignment between interfaces and the possible protocols can be found in chapter 3.9. Depending on the chosen protocol different information is transmitted. Not all possible information is available at any time. Please find below an overview of the properties and telegrams of the protocols realised with FMA21. The availability of the single protocols or rather telegrams may diversify according to the state of software. The single telegrams have different priorities. Priority 0 means the highest priority.

#### 3.1 Protocol Kabcom

The Kabcom protocol is transmitted via RS232 interface. As this protocol is used since years it cannot transmit all information available. A total of five telegrams are available.

##### 3.1.1 Properties

- 8 data bits, 1 stop bit, no parity bit, 9600 baud/s
- When changing one field the corresponding telegram will be immediately transmitted
- If nothing in the fields changes for 250 ms all telegrams will be transmitted anew

##### 3.1.2 Transmitted fields

- Fencing time, round number, status of fencing time
- For each fencer: lamps, score, 1 yellow card or 1 red card, priority

##### 3.1.3 Telegrams

###### Lamps :

0x01, 0x14, 'R', '0', 'G', '0', 'W', '0', 'w', '0', 0x04

###### Time :

0x01, 0x13, 'R', ' ', 'F', '\$', 0x02, 0x10, '0', '0', '0', '0', '0', '0', ':', '0', '0', ':', '0', '0', ':', '0', '0', '0', 0x04

###### Score, cards, priority:

0x01, 0x13, 'K', 'A', 0x02, '0', '0', ':', '0', '/', '0', '0', ':', '0', '/', '0', 0x04

###### Match :

0x01, 0x13, 'O', '2', 0x02, 0x10, '0', '0', '0', '3', '0', '0', '0', 0x04

###### Time Status :

0x01, 0x13, 'S', 'R', 'S', 'S', 'M', 'N', 0x04

#### 3.2 Protocol Swiss Timing

##### 3.2.1 Properties

- 8 data bits, 1 stop bit, no parity bit, 9600 baud/s
- When changing one field the corresponding telegram will be immediately transmitted
- If nothing in the fields changes for 2 s all telegrams will be transmitted anew

##### 3.2.2 Transmitted fields

- Fencing time, round number
- For each fencer: lamps, score, yellow card, red card, priority

### 3.2.3 Telegrams

#### Lamps:

0x01, 0x14, 'R', '0', 'G', '0', 'W', '0', 'w', '0', 0x04

#### Time:

0x01, 0x13, 'R', ' ', 'F', '\$', 0x02, 0x10, '0', '0', '0', '6', ' ', ' ', ' ', '0', '0', ':', '0', '0', ':', ' ', ' ', ' ', ' ', 0x04

#### Score, cards, priority and match:

0x01, 0x13, 'S', 'T', 0x02, '0', '0', '0', ':', '0', '0', '0', 0x02, '0', '0', '0', '0', 0x02, '0', '0', '0', '0', 0x02, '0', 0x02, '0', '0', 0x04

## 3.3 Protocol Swiss Timing 2.0

### 3.3.1 Properties

- 8 data bits, 1 stop bit, no parity bit, 38400 baud/s
- When changing one field the corresponding telegram will be immediately transmitted after prioritisation
- If nothing changes in the high-priority fields for 1.2 seconds or for 12 seconds in the low-priority fields all telegrams will be transmitted anew

### 3.3.2 Transmitted fields

- Fencing time, round number, status of fencing time, weapon, information of the fight
- For each fencer: lamps, score, yellow card, red card, black card, video proof, priority, name of the fencer, nation of the fencer

### 3.3.3 Telegrams

#### Message1 Lamps Prio 0:

0x01, 0x14, 'R', '0', 'G', '0', 'W', '0', 'w', '0', 0x04

#### Message2 Time Prio 0:

0x01, 0x13, 'N', 0x02, '0', '0', ':', '0', '0', 0x04

#### Message3 Competition Data Prio 1:

0x01, 0x13, 'D', 0x02, '0', '0', ':', '0', '0', '0', '0', '0', '0', '0', '0', 0x02, '0', '0', '0', '0', '0', 0x02, '0', 0x02, '1', 0x02, '3', '3', 0x04

#### Message4: Scoring Machine Info & Status Prio 1 :

0x01, 0x13, 'I', 0x02, '0', 0x02, '0', 0x02, '0', 0x02, '0', 0x04

#### Message5 Left Fencer Info Prio 1: (not implemented yet)

#### Message6 Right Fencer Info Prio 1: (not implemented yet)

#### Message7 Competition Information Prio 1: (not implemented yet)

### **3.4 Protocol internal bus**

This protocol is used to control scoring machines of previous generations (FMAxx series) as well as the allstar extension box, the AFL converter and the AFL router series. These are the only devices supported by this protocol.

#### **3.4.1 Properties**

- 8 data bit, 1 stop bit, no parity bit, 38400 baud/s
- Constant data transmission with 20 ms break between telegrams

#### **3.4.2 Transmitted fields**

- Fencing time, round number, status of fencing time, weapon
- For each fencer: lamps, score, yellow card, red card, ground lamps



## 3.5 Protocol internal bus V19

This protocol is an extension of the protocol already explained in chapter 3.4.

The fields 'black card', 'several red cards' and 'state of the inversion of sides' were added.

Please note: Previous scoring machines of the FMAxx series are not able to communicate with this protocol.

### 3.5.1 Properties

- 8 data bit, 1 stop bit, no parity bit, 38400 baud/s
- Constant data transmission with 20 ms break between telegrams

### 3.5.2 Transmitted fields

- Fencing time, round number, status of fencing time, weapon, state of the side change
- For each fencer: lamps, score, yellow card, red card, black card, ground lamps

## 3.6 Protocol allstar fencing link

### 3.6.1 Properties

- 8 data bit, 1 stop bit, no parity bit, 115200 baud/s

## 3.7 Protocol Cyrano

The Cyrano protocol is a standardised protocol to transmit fencing information and to control the management of the fight or to communicate between scoring machine and result management software. This protocol is only used for transmission on the network interface. It uses a total of seven telegrams which are exchanged between master FMA21 of the piste and the result server.

The Cyrano protocol defines four states, 'Waiting', 'Halt', 'Fencing' and 'Pause'. The three latter states are so called 'active' states.

To control the management different commands are used. These commands are transmitted and carried out by using buttons on the touch screen, on the remote control or with different telegrams.

The commands 'Start' and 'End' activate or deactivate/safe a fight. After saving the scoring machine is informed by the telegrams 'Ack' or 'Nak' whether the fight information was transferred or whether the current results have to be checked. 'Next' and 'Previous' are used in inactive state to load the next or previous fight.

To see the detailed state machine please see chapter 4.3.

### 3.7.1 Properties

- Bidirectional UDP transmission to port 50100
- When changing one field the corresponding telegram will be immediately transmitted
- During an active fight the data on the scoring machine cannot be influenced

### 3.7.2 Transmitted fields

- Fencing information (number of piste, fight no., name of competition), start time, fencing mode (individual or team), weapon
- Fencing time, round number, state of fight, name, nation and ID of referee
- For each fencer: lamps, score, yellow card, red card, black card, priority, name, nation and ID of fencer, state of spare fencer
- Cyrano states

### **3.7.3 Telegrams**

Result server → master FMA21:

Hello message:

Disp message:

Ack message:

Nak message:

Master FMA21 → result server:

Next message:

Prev message:

Info message:

## **3.8 allstar protocol extension**

As the standardised Cyrano protocol does not include all information an extension is necessary. It has no influence on the standardised protocol and operates independently.

### **3.8.1 Properties**

- Bidirectional TCP transmission to port 28015 (partly encrypted)
- Master FMA21 connects to the result server
- During an active fight the data on the scoring machine can not be influenced

### **3.8.2 Transmitted fields**

- Pictures and flags of fencers, team pictures, team flags, standby picture, break picture
- Maximum number of rounds
- Name, nation and ID of teams, score of single fencers in team competitions
- Remaining number of video requests
- Name, nation, picture, flag of next fencer in this round or next team competitions
- RFID of fencer and referee
- Rounds and KO tableau information
- Medical and technical emergency call as well as calling DT

### 3.9 Which protocols with which interfaces

Below please find an overview of the availability of protocols with the particular interfaces.

Protocol\interface	RS232	RS422	RS485	LAN
Kabcom	available (default from V0.5.0)	available	available (master mode)	not available
SwissTiming	available	available (default from V 0.5.0)	available (master mode)	not available
Swiss Timing 2.0	available	available	available (master mode)	not available
Internal Bus	not available	not available	available (currently only master mode) (default from V 0.5.0)	not available
Internal Bus V19	available	available (default from V 0.9.0)	available (currently only master mode)	not available
allstar Fencing Link	available	available	available (master mode)	not available
Cyrano	not available	not available	not available	available
allstar extension	not available	not available	not available	available

Please note: The individual choice of protocols to interfaces via the property menu is not yet implemented in the current software version V 0.9.6 which means that the default settings cannot be changed yet.

#### 4. Network connection (LAN)

Several FMA21 can be connected to a network. This enables that the FMA21 devices can change data between each other as well as with a central data server. To use this functionality each FMA21 has to be clearly identifiable in the LAN which can be done with IP addresses. Therefore, each device in the network must be given a unique IP address. If this is not provided the connected devices or the network may not operate properly. To start up a network properly please see chapter 4.2.

IP addresses in the network are static. This means that each device connected to the network must have a fixed IP address. The structure as well as the distribution of the IP addresses are defined. It is a class B net (172.20.x.x, 255.255.0.0) with the following sub groups:

Sub group 0: administration pc (server and result management)

Sub group 1: all network devices and scoring machines of piste 1

Sub group 2: all network devices and scoring machines of piste 2

Sub group 3: all network devices and scoring machines of piste 3

etc.

Within the sub groups the IP addresses are static as well and already defined.

Sub group 0:

172.20.0.1	Result server
172.20.0.2	allstar back end server
172.20.0.20 – 39	Ophardt control pc
172.20.0.100 – 199	Swiss Timing control pc and monitors
172.20.0.240 – 249	allstar managed switches

Sub group 1:

172.20.1.1	Master FMA21 (main (master) scoring machine of piste 1)
172.20.1.2	Slave 1 FMA21 (display (slave) scoring machine of piste 1)
172.20.1.3	Slave 2 FMA21 (display (slave) scoring machine of piste 1)
172.20.1.4	Slave 3 FMA21 (display (slave) scoring machine of piste 1)

etc.

Sub group 2:

172.20.2.1	Master FMA21 (main (master) scoring machine at piste 2)
172.20.2.2	Slave 1 FMA21 (display (slave) scoring machine at piste 2)
172.20.2.3	Slave 2 FMA21 (display (slave) scoring machine at piste 2)
172.20.2.4	Slave 3 FMA21 (display (slave) scoring machine at piste 2)

etc.

Sub group x:

- 172.20.x.1 Master FMA21 (main (master) scoring machine at piste x)
- 172.20.x.2 Slave 1 FMA21 (display (slave) scoring machine at piste x)
- 172.20.x.3 Slave 2 FMA21 (display (slave) scoring machine at piste x)
- 172.20.x.4 Slave 3 FMA21 (display (slave) scoring machine at piste x)
- etc.

The following illustration explains the connection:

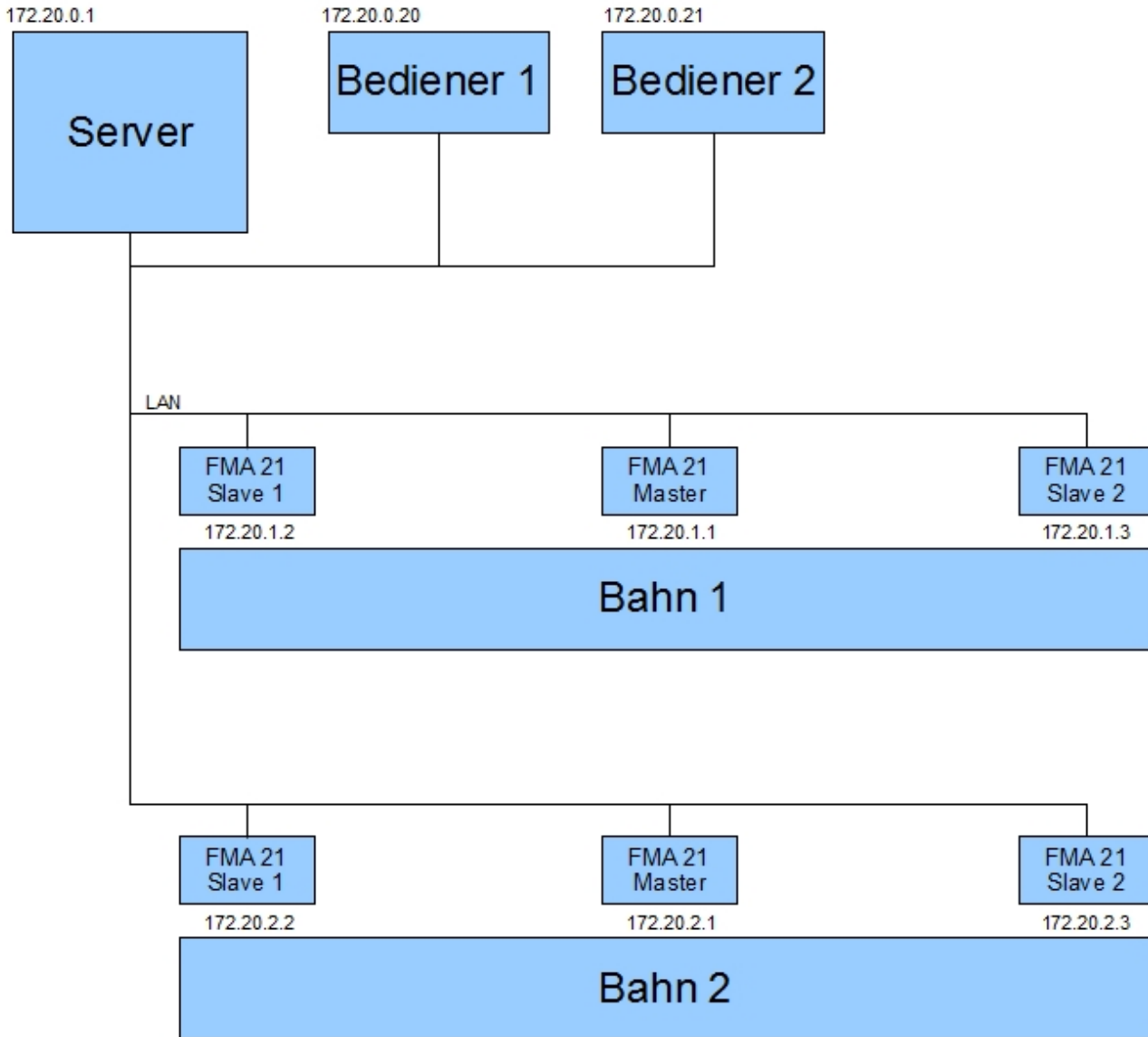

Fig 1: Typical network configuration

## 4.1 Network protocols

To transmit information within the network protocols are used as well. In this case, the standardised Cyrano protocol is used. This protocol transmits the standardised information from the result management server to the single piste servers. But the protocol does not comprehend all necessary data (as for example pictures, flags etc.). We therefore use a protocol extension which operates independently and does not influence the Cyrano protocol. Details regarding the various protocols were already explained in chapter 3.7 and 3.8.

The following illustrations show the typical configurations with or without allstar protocol extension.

The illustration below explains the information flow in a network configuration with Cyrano protocol. The two slave scoring machines do not have a direct connection to the server. They receive data by the respective master scoring machine of the piste via allstar protocol.

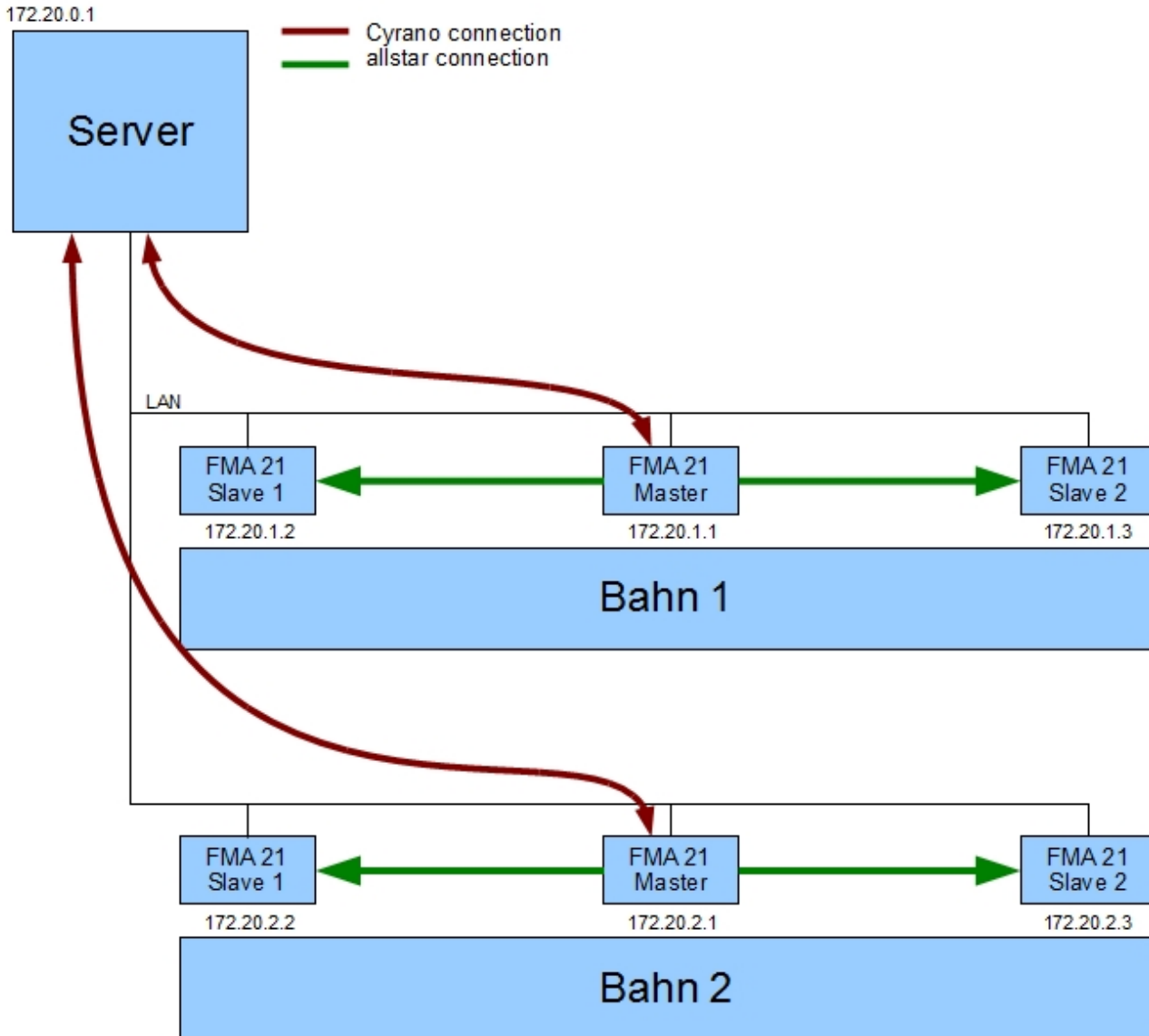

Fig 2: Network configuration with connection to result server via Cyrano

The following illustration explains the information flow for a network configuration with Cyrano and allstar protocol.

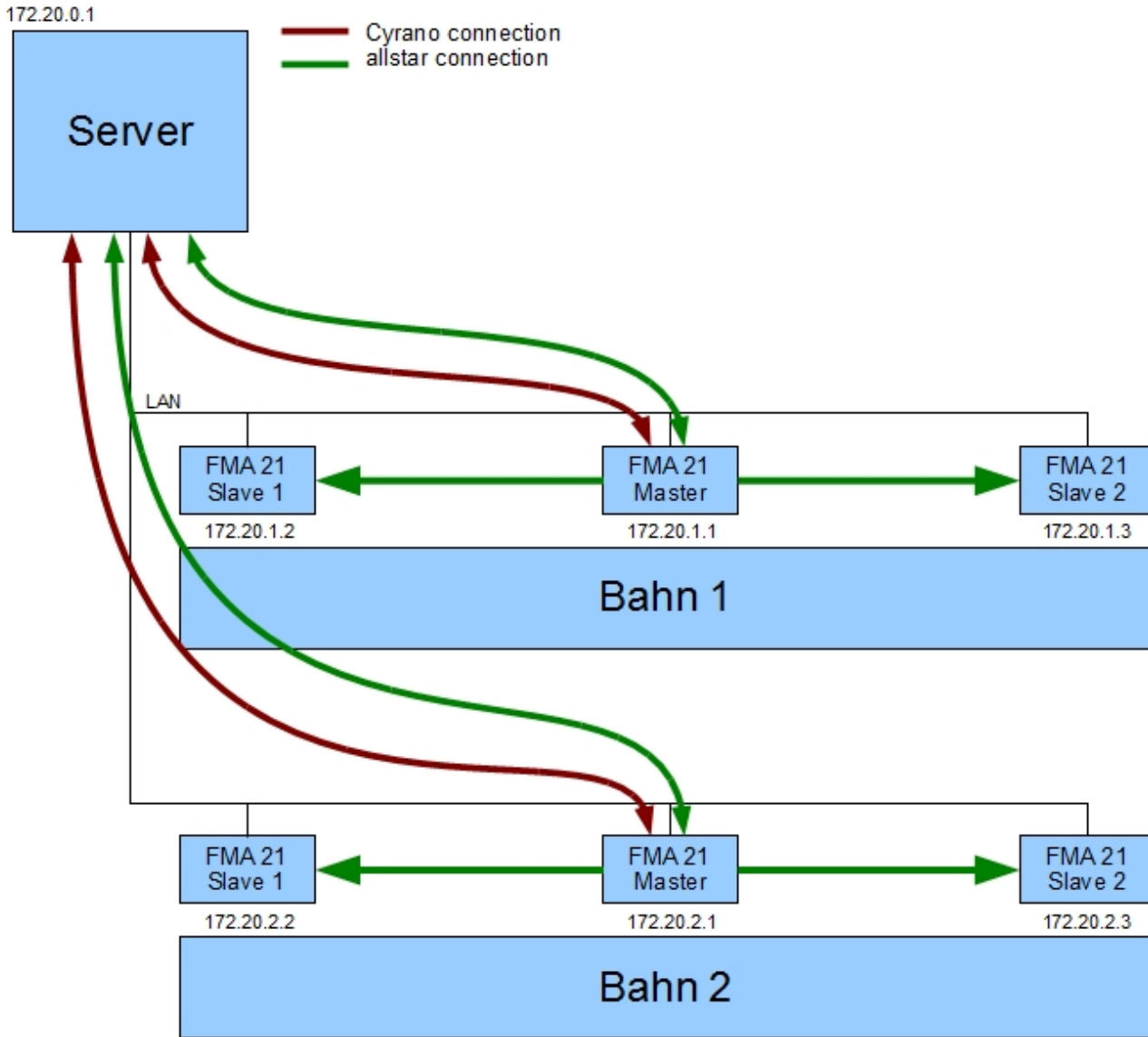

Fig 3: Network configuration with connection to result server via Cyrano and allstar



## 4.2 Network setup with FMA21

To setup a network the FMA21 scoring machine as well as all other network devices must have a unique IP address. If this is not provided the network may not work reliably. The IP address of the scoring machine is automatically generated from the piste number and if applicable from the slave number (for master scoring machines the IP address is 172.20.<piste no>.1; for the slave scoring machines the IP address is 172.20.< piste no >.<slave no + 1>). To operate a network successfully, to add another scoring machine or a different network-compatible device to the existing network the following steps have to be carried out:

1. Make sure that no scoring machine is connected to the network (If necessary, unplug the network cable). Carry out steps 2 – 8 for each scoring machine. For other network devices it is absolutely necessary to set the IP address **BEFORE** plugging in the network cable.
2. Position FMA21 on its stand and connect all cables **except network cable** to FMA21. It is important that the network cable (LAN cable) is not yet plugged in at that time.
3. Switch on FMA and wait until it has booted.
4. Please choose profile. If the scoring machine shall act as master of this piste please choose profile Cyrano or Cyrano + XX. XX is the choice of the result system supplier (for example Ophardt Team, Mask etc.). If the scoring machine shall act as slave device (copying the display of the master scoring machine) please choose profile 'Slave (net)' or 'Slave (net) inverted' (for example to show an inverted version of the master display on the opposite side). Before changing the profile you may have to enter a password which is 134241.
5. Please enter the piste number. If the scoring machine shall act as slave device the slave number must be set. Before changing the piste or slave number you may have to enter a password which is 134241.

Please note: The slave number can appear only once per piste. An automatic verification of already occupied pistes or slave numbers is not carried out at the moment.

6. Wait until the status message has disappeared.
7. Plug in the network cable (LAN).
8. Please choose the same profile as described under point 4.
9. The scoring machine tries to setup a connection. The master scoring machine tries to setup a connection to the result system server (172.20.0.1), the slave scoring machines to the corresponding master scoring machine of this piste. The successful connection can be checked by means of Cyrano status LED's (see pictures 4.1 – 3). A yellow lamp signifies the connection via Cyrano a green lamp signifies a connection via allstar protocol.

Please note: It may take up to 15 s to successfully setup a connection. If the connection breaks off it may take up to 40 s until the status bar disappears.



Fig 4.1: No connection available



Fig 4.2 Cyrano connection available



Picture 4.3 Cyrano & allstar connection available

### 4.3 State machine with Cyrano

The following illustration explains the function of the state machine by means of the Cyrano protocol:

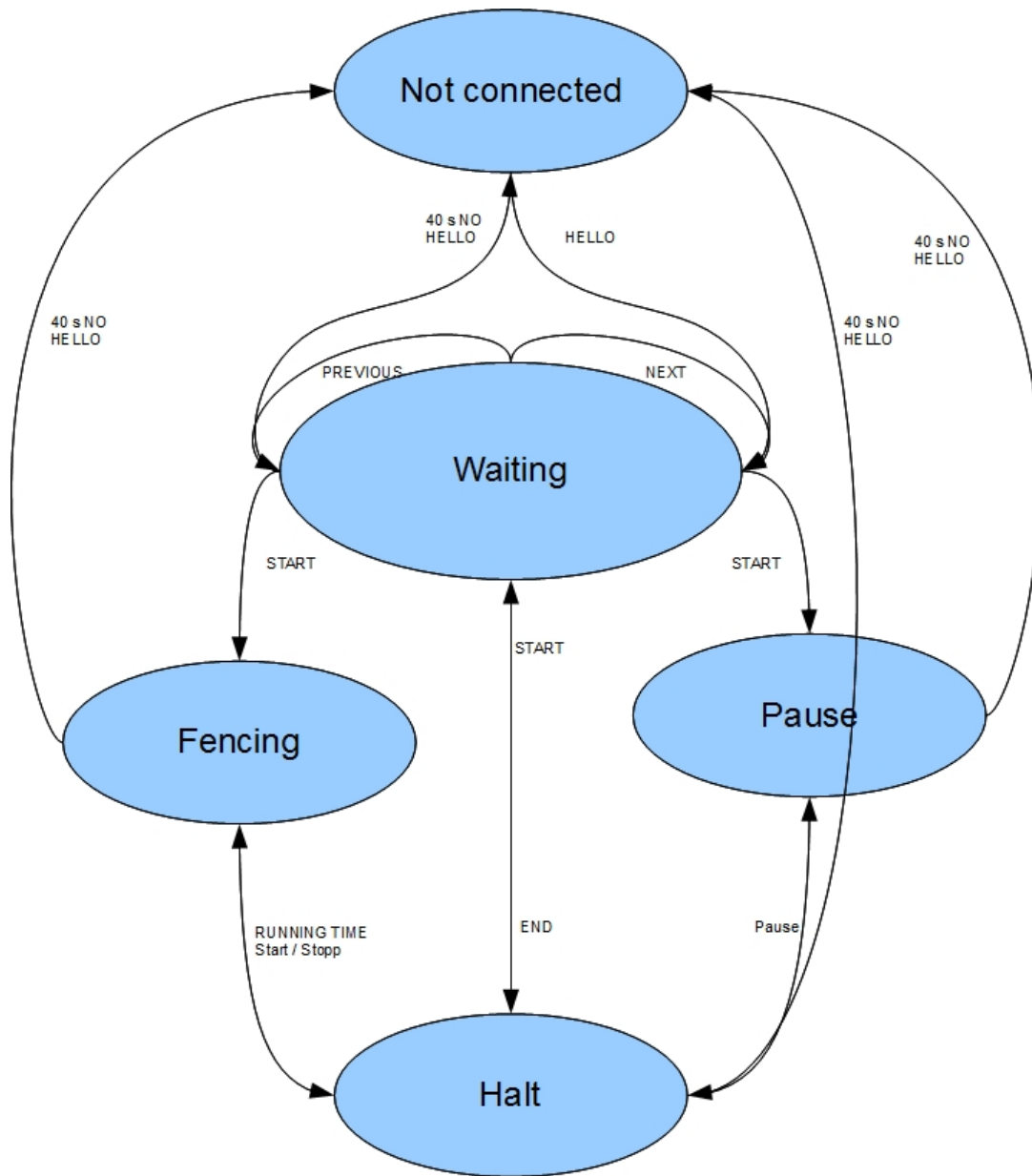

Fig 5: States of FMA21 with Cyrano protocol

The commands 'Start', 'End', 'Next' and 'Previous' are carried out by using buttons on the touch screen or by using key combinations on the remote control FB3a. As the current remote control does not have extra keys for Start, End, Next and Previous the following key combinations have to be used:

Start: <FN> + <Clock Start/Stop>

End: <FN> + <Clock Start/Stop>

Next: <FN> + <Match+>

Previous: <FN> + <Match->

The following illustration explains the different states with their commands in detail:

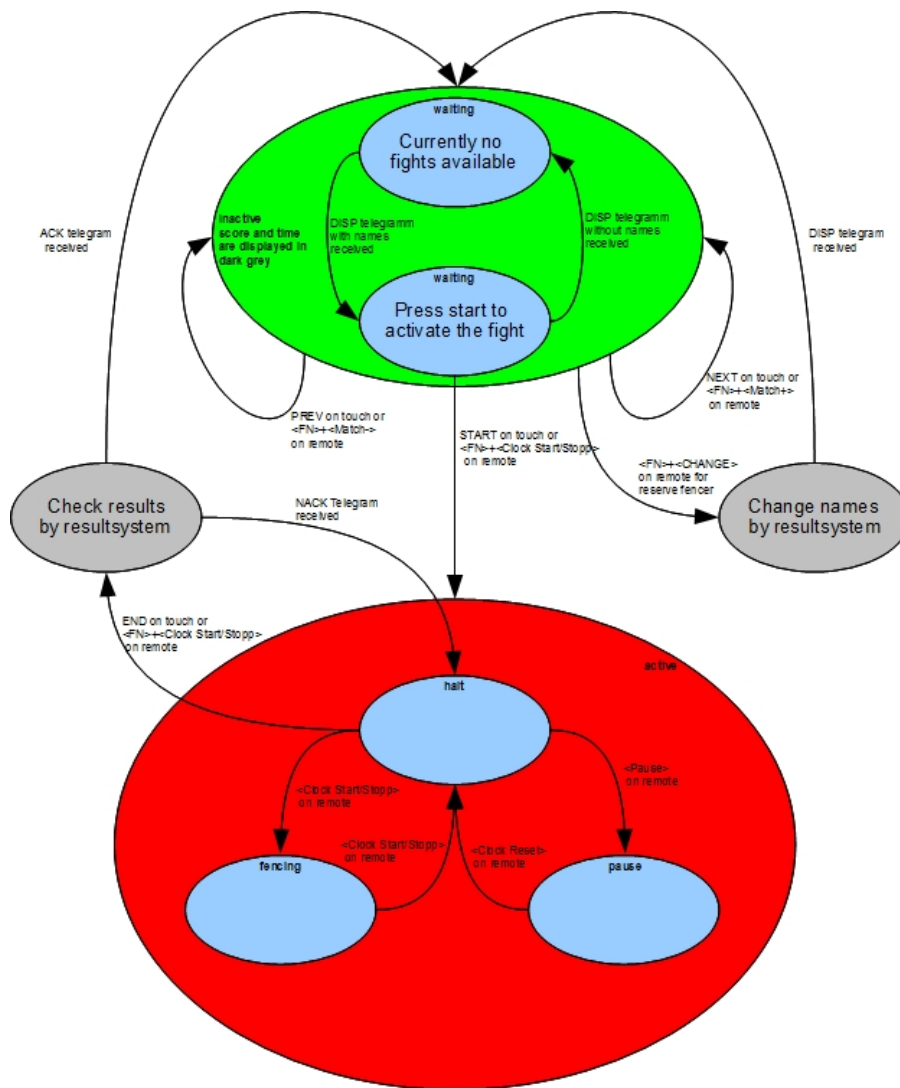

The above illustration shows that after starting FMA21 it is in the inactive state (green) 'waiting'. In this state the scoring machine can receive information from the result system. As long as it has not received current fight information (names) by means of the 'DISP' command the message 'No further match available' is visible on display. After receiving names the message 'Please press <Fn>+<Start> to activate the match' appears. Now, the fight can be activated by pushing the key combination on the remote control or the start button in the network menu. The scoring machine changes into the active state (red). An influence by the result system is not possible any more. To stop the fight the key combination <FN>+<Start/Stop> on the remote control or the stop key in the network menu has to be pushed again. After confirming the scoring machine sends the command for saving to the result system and waits for data validation. With the ACK/NAK command the result system sends back the result to the scoring machine. In case of NAK the scoring machine reverts to the active state 'Halt' and the message 'Please check your results!' appears. Otherwise the scoring machine returns to the inactive state 'Waiting' and waits for new fights.

During the inactive state the key combinations <FN>+<Match+> and <FN>+<Match-> as well as the ,Next' and ,Prev' buttons in the network menu are used to scroll through the fights in one round or in the team competition.

If a spare fencer shall be replaced during a team competition the change is marked by the key combination <FN>+<CHANGE> before activating the fight. Now the message 'To activate or delete spare fencer please press <FN>+<Cards>' appears.

By pushing the corresponding key combination on the remote control the command is sent to the result system. This replaces the existing names by the spare fencers' names and sends the updated information with a ,DISP' message back to the scoring machine.

The result system takes care that for all following fights the correct names are transmitted. The same procedure is used to take back a spare fencer who was replaced by mistake.

# FB 03

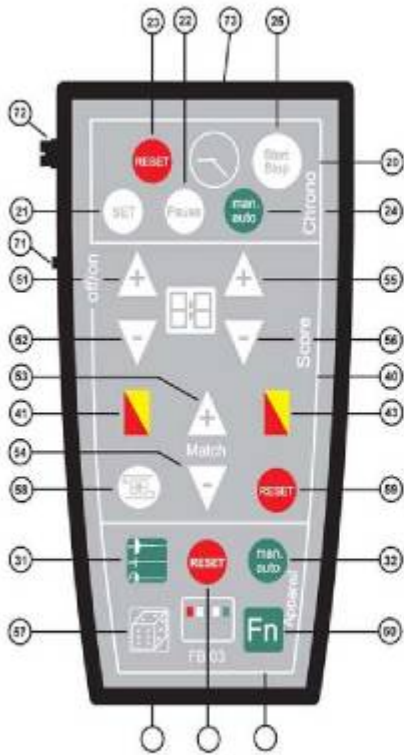

## Typischer Gefechtsablauf mit Result-Management-System "Ophardt"

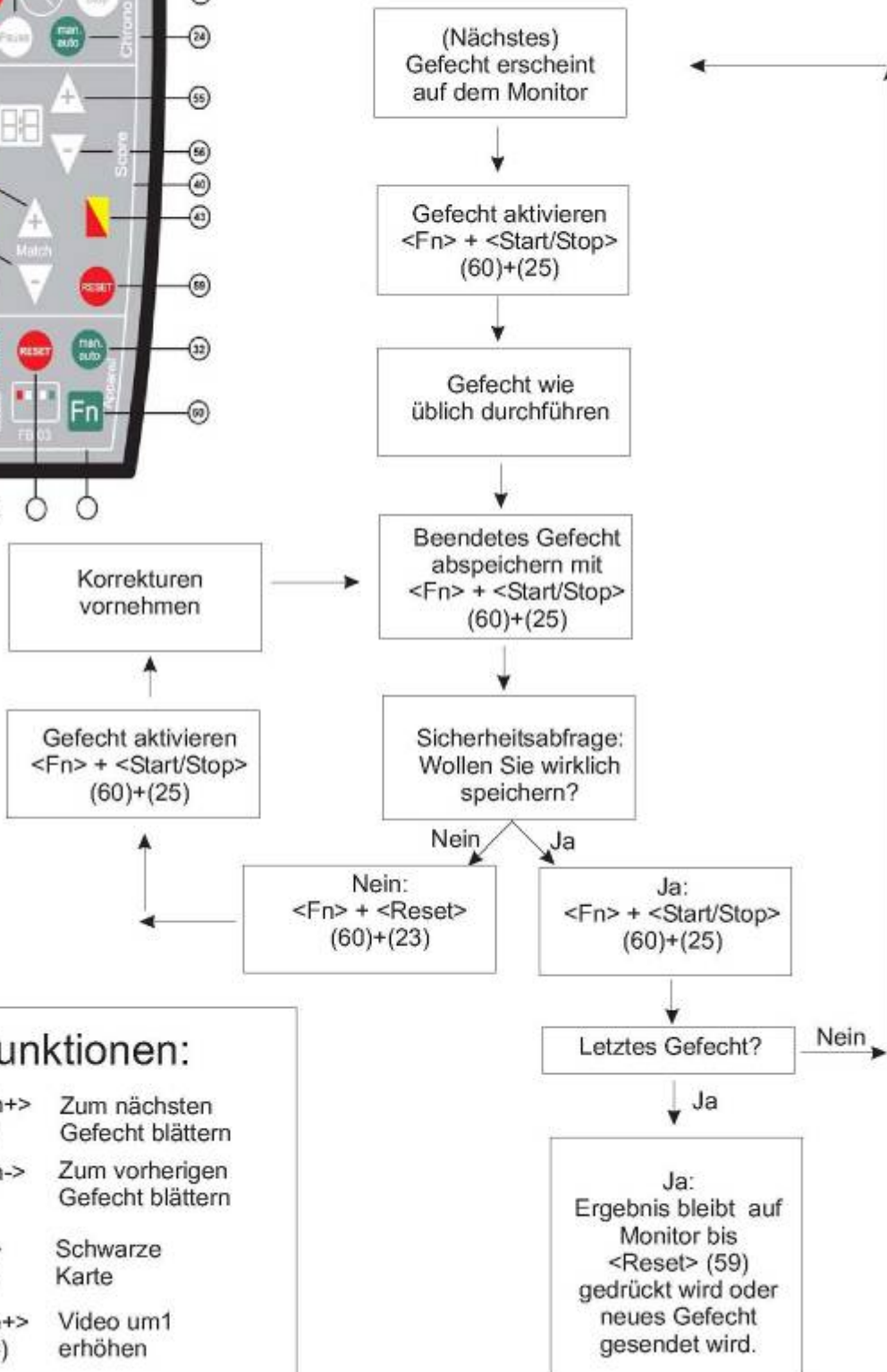

### Neue Funktionen:

- <Fn>+<Match+> (60)+(53) Zum nächsten Gefecht blättern
- <Fn>+<Match-> (60)+(54) Zum vorherigen Gefecht blättern
- <Fn>+<card> (60)+(41/43) Schwarze Karte
- <Fn>+<Score+> (60)+(51/55) Video um1 erhöhen
- <Fn>+<Score-> (60)+(52/56) Video um1 vermindern

#### 4.4 allstar Cyrano server

For companies which do not want to realise their own network programming we offer a server software (allstar Cyrano server) which takes care of the overall Cyrano network communication. This server is controlled via small text files. On demand additional information can be requested.

The following illustration shows the setup:

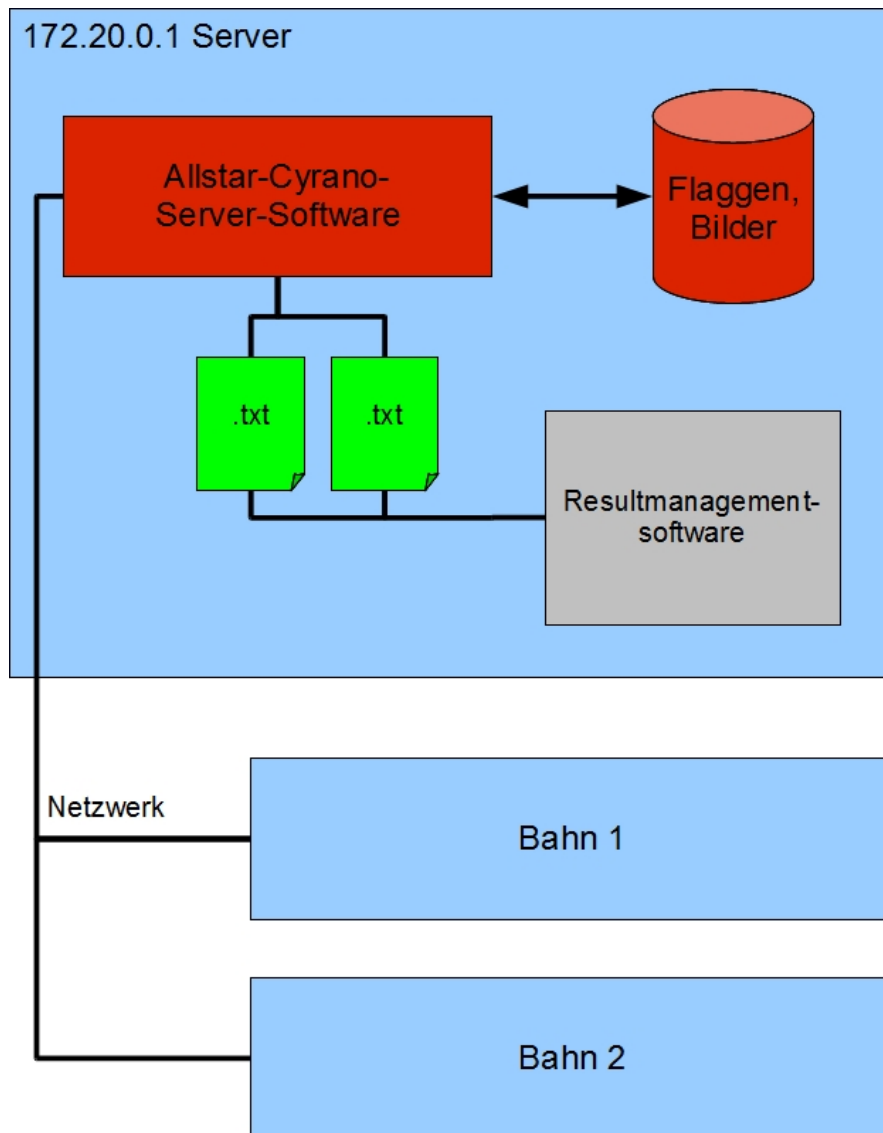

Fig 6: Integration with allstar Cyrano server

## 4.5 Network tips

If there is no connection between scoring machine and result server for any reason please follow the steps below:

1. Has the setup of the scoring machines been carried out according to chapter 4.2?
2. Are the network cables connected properly? Most network sockets (LAN sockets) have status LED's. Please check at each socket if the corresponding link LED is on.
3. Disconnect all devices which are currently not required from the network and try to connect to one single scoring machine.
4. Check if the requested server software is running and if the firewall allows packages to pass at the necessary ports (UDP 50100, TCP 28015).
5. Deactivate all installed firewalls and security suites on the server.

Please note: The scoring machine currently does not support checking the network connection by ping command which means that FMA21 does not reply to ping requests.